

4

3

2

1

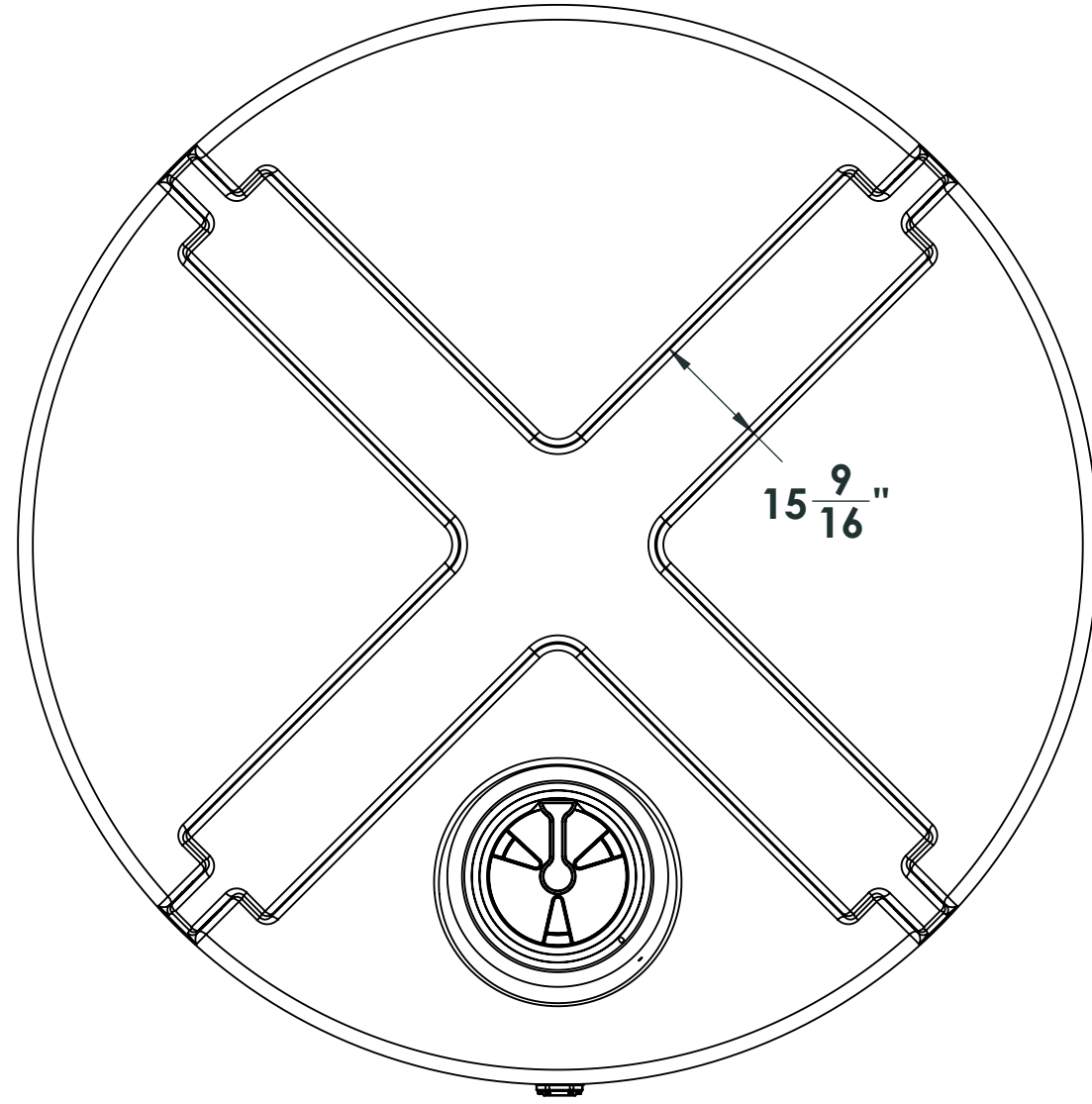

16 inch lid

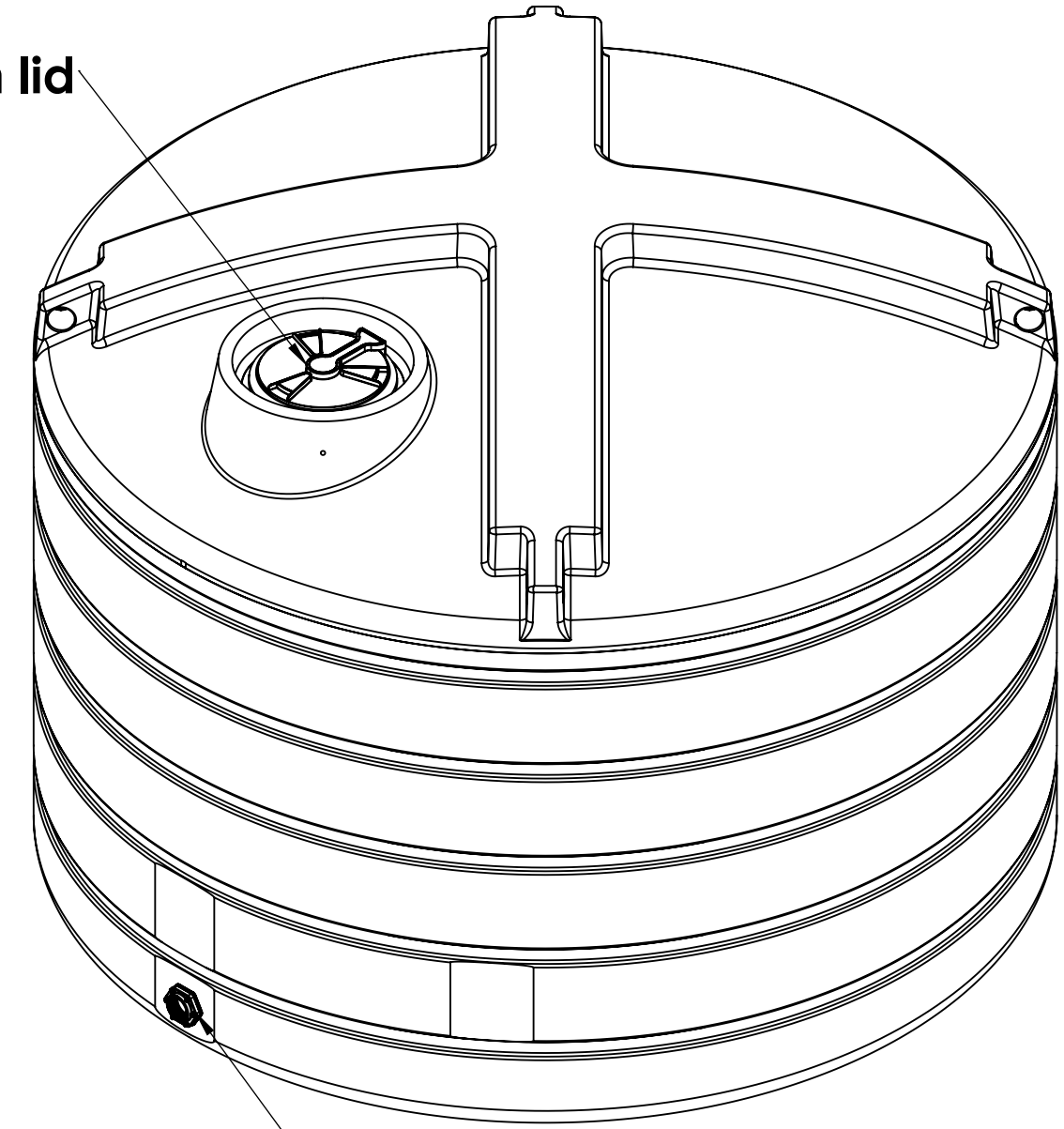

3 inch bolted fitting

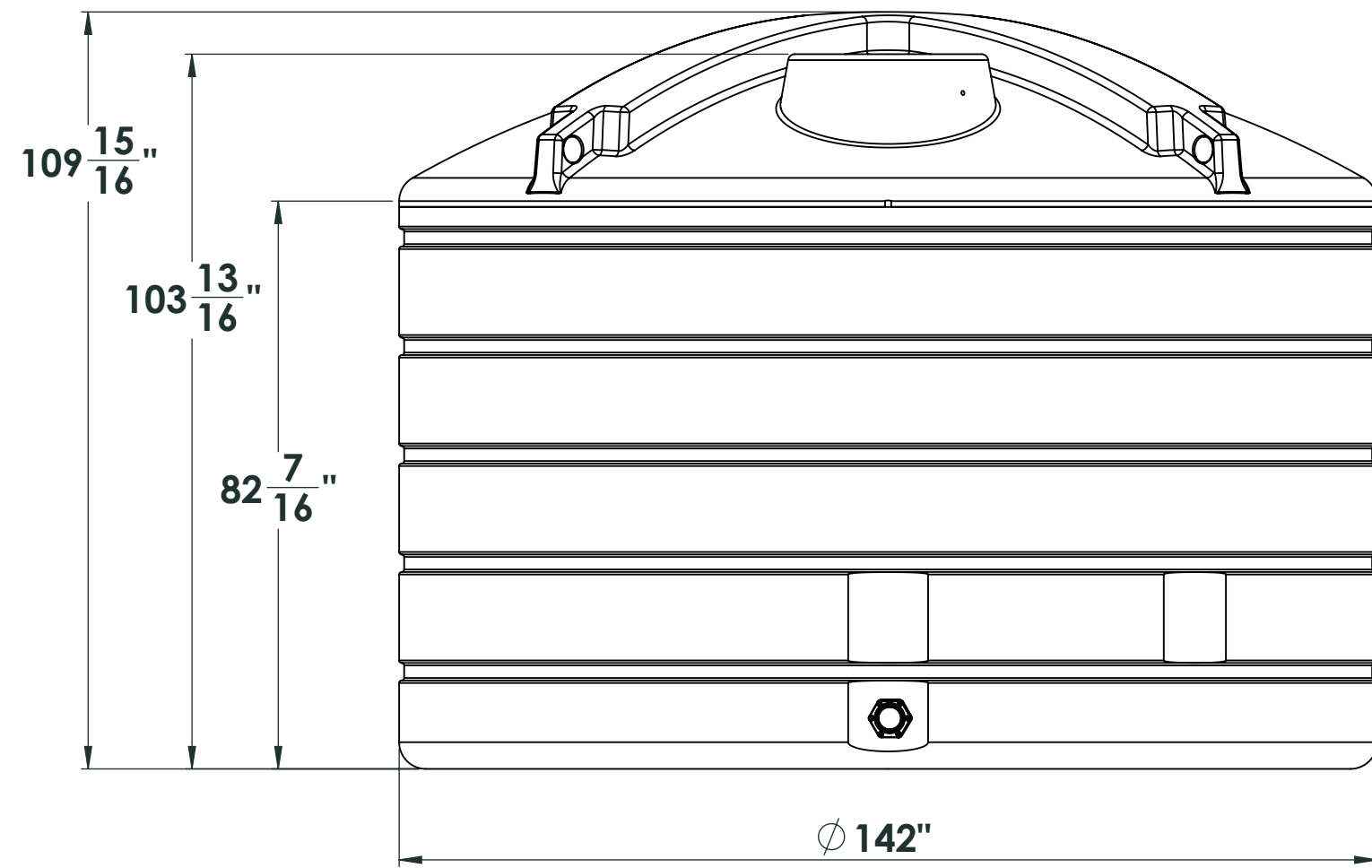

NOTE: Allow +/- 1.5% Shrinkage

PROPRIETARY AND CONFIDENTIAL
 THE INFORMATION CONTAINED IN THIS DRAWING IS THE SOLE PROPERTY OF ENDURAPLAS LLC. ANY REPRODUCTION IN PART OR AS A WHOLE WITHOUT THE WRITTEN PERMISSION OF ENDURAPLAS LLC IS PROHIBITED.

		UNLESS OTHERWISE SPECIFIED:		NAME	DATE	ENDURAPLAS LLC	
		DIMENSIONS ARE IN INCHES		DRAWN	DNS	11/1/16	TITLE:
		TOLERANCES:		CHECKED			THV06011
		FRACTIONAL ±		ENG APPR.			SIZE DWG. NO.
		ANGULAR: MACH ± BEND ±		MFG APPR.			REV
		TWO PLACE DECIMAL ±		Q.A.			1
		THREE PLACE DECIMAL ±		COMMENTS:			
		INTERPRET GEOMETRIC TOLERANCING PER:					
		MATERIAL					
		FINISH					
NEXT ASSY	USED ON	APPLICATION		SCALE: 1:50 WEIGHT: SHEET 1 OF 1			
		DO NOT SCALE DRAWING					

4

3

2

1

D

D

C

C

B

B

A

A