

Copyright. All information furnished within this document, electronic file or design correspondence is the property of Den Hartog Industries, Inc. and shall not be used, disclosed to others or copied without the expressed written consent of Den Hartog Industries, Inc.

LID TRIM AND FASTENING DETAIL

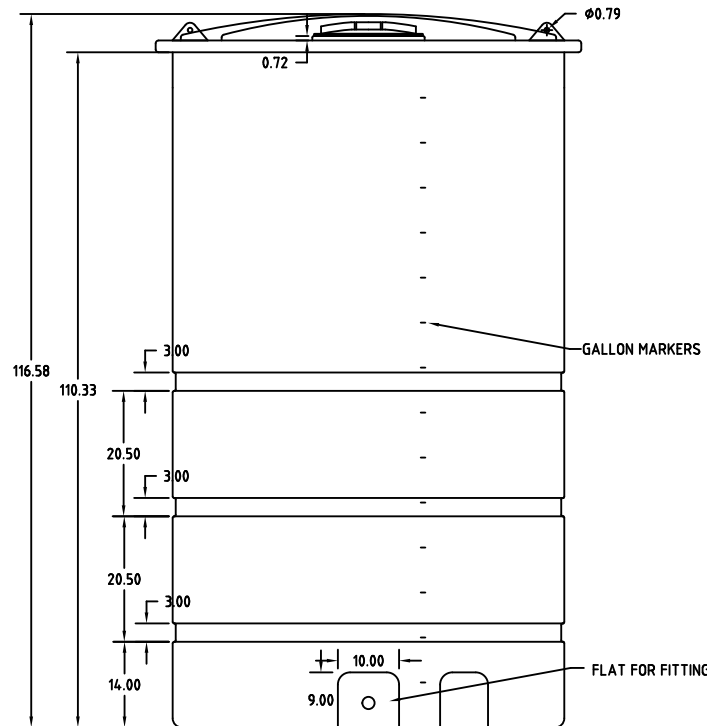
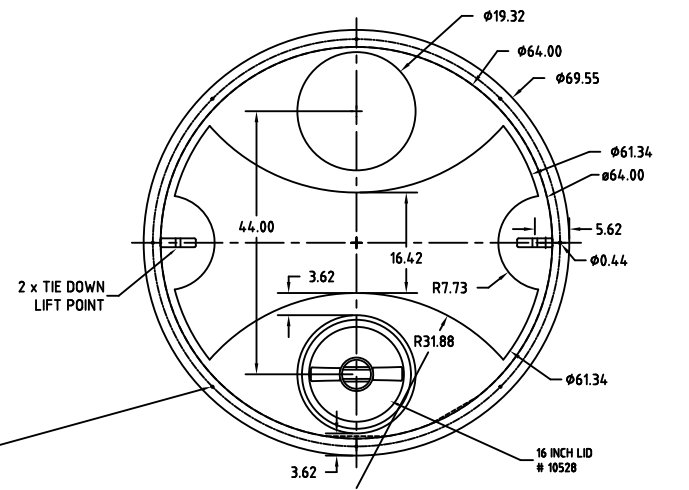
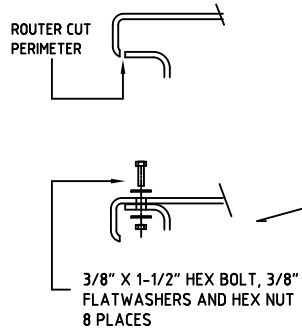

REV	DESCRIPTION	BY / DATE	CCN
ALL DIMENSIONS ARE IN DECIMAL INCHES TOLERANCES UNLESS OTHERWISE SPECIFIED			
POLYETHYLENE		METAL	
±1% @ 68° F		DECIMAL ± .125" FRACTION ± 1/4" ANGLE ± 1°	

THIRD ANGLE PROJECTION ANSI 14.5M
SHOT WEIGHT: 335 LBS.
SHIPPING WEIGHT: 337 LBS.
FINISH:

DRAWN / DATE DHJ 2/2/12	MATERIAL 10420
APPRD. / DATE REH 3/6/12	NOTES: 1. .34 WALL



Den Hartog

INDUSTRIES, INC.

Ace Roto-Mold Injection Molding Blow Molding Sow joy

4010 HOSPERS DRIVE S. BOX 425, HOSPERS, IOWA 51238-0425

DESCRIPTION 1505 GALLON OPEN TOP WITH BOLT ON TOP	
SCALE N.S.	PART NO. OP1505-64